

SC adapters

Description:

The SC adapters are designed and manufactured according to JIS, IEC, EIA/TIA and ANSI specifications for intermateability and optical performance. The SC adapters are offered for MM or SM applications, designed for connectors with PC and APC polishing method. The ordering code allows exact specification of your demands concerning sleeve type (phosphor bronze or zirconia) and adapter variant, duplex version is also available. A wide range of hybrid adapters is provided to enable interconnection between different connector types.



Features:

- Simplex and duplex panel cutouts
- Panel clip for easy installation
- Available in several standard colors
- Available without flanges
- Hybrid types provided

Application:

- Telecom
- LAN, WAN
- CATV
- Sensor Systems
- Measuring Technique
- Utilities, Railways

Ordering code:

A - SC (-D) / (A)PC - XX - XX XX - XX

type SC SC -D LC ST LSH FC	sleeve 01 zirconia 02 phosphor bronze	body 01 plastic, metal clip 03 metal BL blue (PC) GR green (APC) MT metal	01 flange 02 no flange 03 square flange
---	--	---	---

Dimensions:

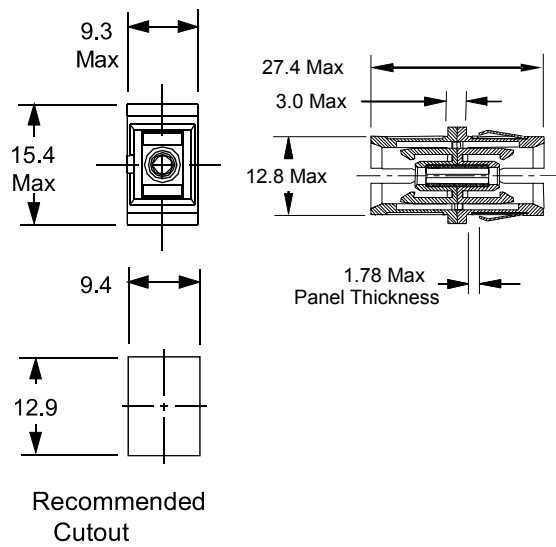
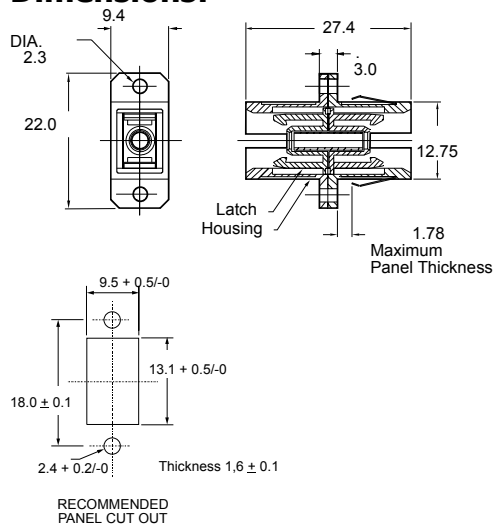

Samples of Adapters



A-SC/APC-01-01 GR-01



A-SC/APC-01-01 GR-02



A-SC/PC-01-01 BL-01



A-SC/PC-02-01 BL-01



A-SC/PC-01-01 BL-02



A-SC-D/APC-01-01 GR-01



A-SC-D/PC-02-01 BL-01



A-SC-ST/PC-02-01 BL-01



A-SC-FC/PC-01-01 BL-01



A-SC-FC/APC-01-01 GR-01



A-SC-FC/PC-01-01/03 BL-01



A-SC-FC/APC-01-03 MT-01



A-SC-FC-D/PC-02-03 MT-01



A-SC-FC/APC-01-03 MT-03